

# **SERVICE MANUAL**

## **VOX VT80+**



### **TABLE OF CONTENTS**

#### **VT80+**

Block Diagram:	2
Schematic Diagram:	3
Hookup:	5
TestMode:	7
PARTS LIST:	14



Issued: Feb.17, 2011  
Ver.1.0  
©2011 VOX AMPLIFICATION LTD.

VOX VT80+  
BlockDiagram

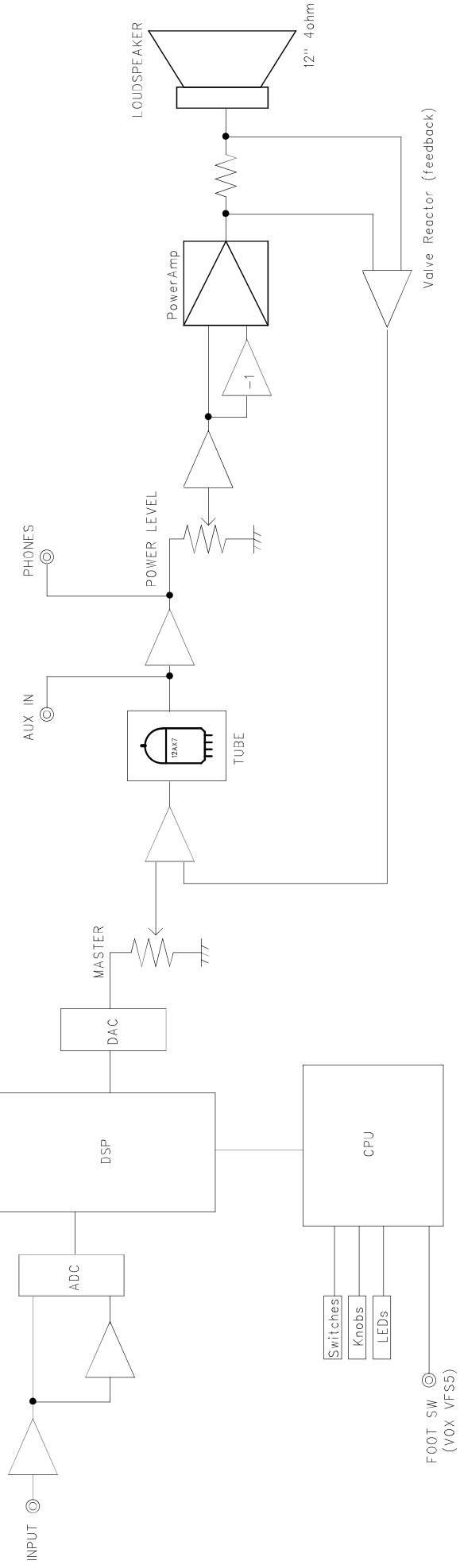

POWER SUPPLY

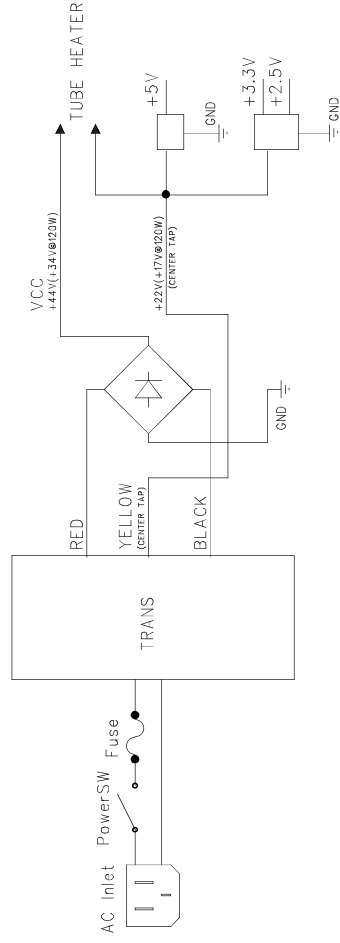

MARK	REVISION	REASON	DATE	REVISOR

DRAWN BY	DESIGNED BY	CHECKED BY	MODEL TITLE
S.TSUNASHIMA			BlockDiagram

  

DRAWING NO.	DATE
	6.Jan.2011



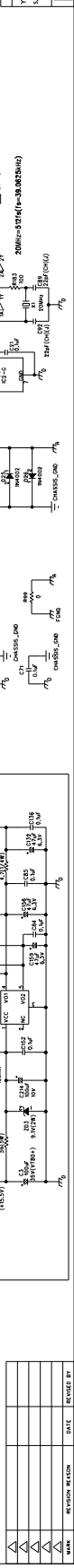
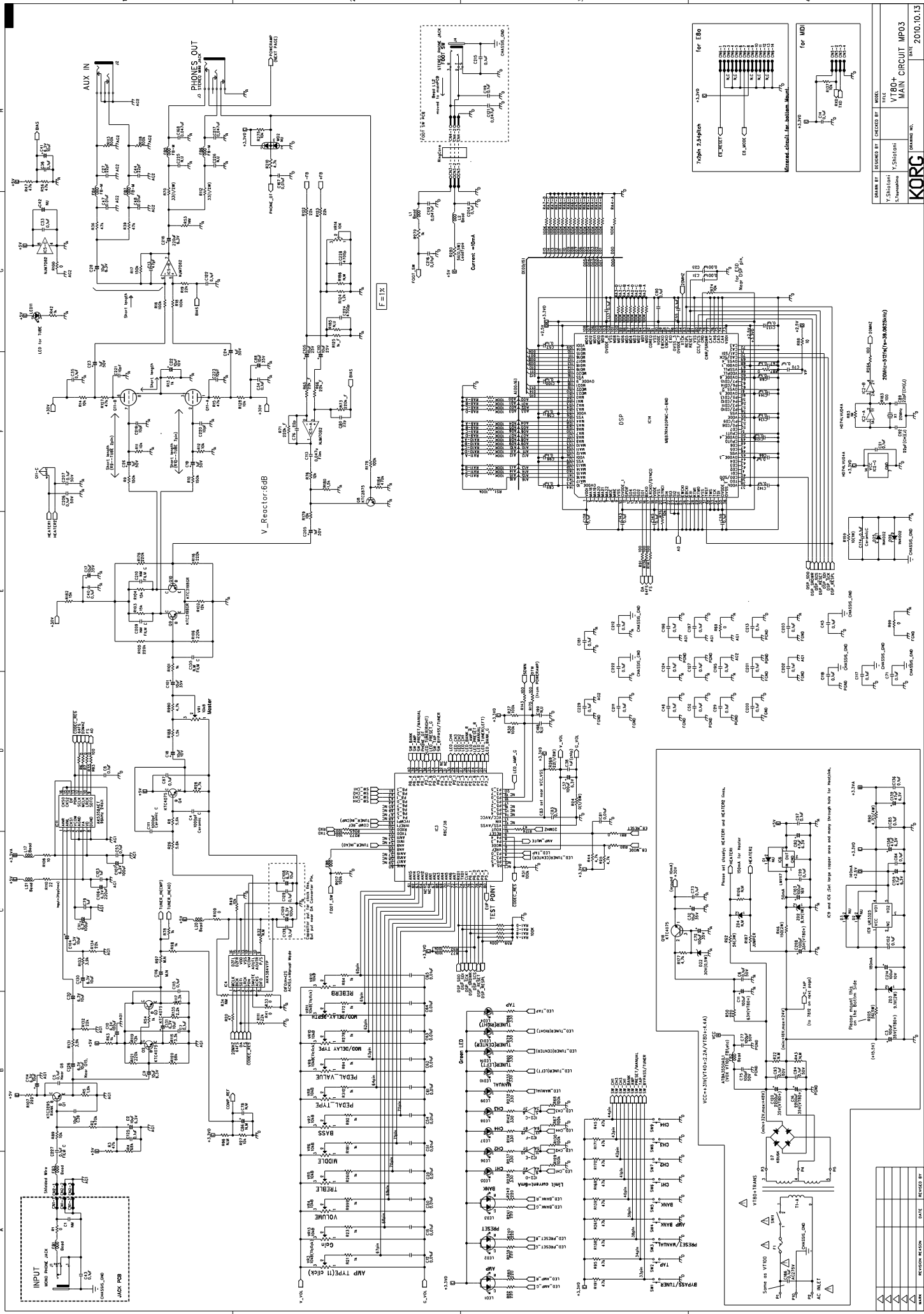



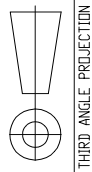

THIRD ANGLE PROJECTION

NO	DESCRIPTION	SPECIFICATION	QTY
1	MAIN RB ASSY	VT80+	1
2	JACK RB ASSY	VT80+	1
3	FOOT S/W PCB ASSY	VT80+	1
4	MAIN CHASSIS	386X5X120 EGI 15F	1
5	FRONT PANEL	PVC 0.51 316X80 HAIRLINE BLACK	1
6	REAR PANEL	PS 0.51 336X66 BLACK	1
7	VOLUME KNOB-SMALL	ABS (CREAM/CHEMHEAD)	8
8	VOLUME KNOB-"A"	ABS BLACK(K00R0050)	5
9	TACK KNOB-"B"	NBR Ø7	8
10	TACK KNOB-"A"	MBS55W 3X6 NI	8
11	SCREW	TPDS 3X6 NI	2
12	FRANGE NUT	M4 NI	5
13	TUBE	12AX1A65	1
14	TUBE RETAINER	12AX1B(SPRO012)	1
15	JACK NUT	ABS BK	1
16	JACK NUT	ERIBP2J	1
17	JACK WASHER	ABS BK(BP2J)	1
18	VOLUME NUT	M7 NI	13
19	VOLUME WASHER	Ø7 NI	5
20	TRANS	VT80+	1
21	POWER SWITCH	RL3-421-H-0-BK	1
22	INLET	SC-RF-21	1
23	FUSE	MBS LX10 BK	1
24	SCREW	MBS 3X16 NI	4
25	SCREW	MBS 3X16 NI	2
26	NUT	M3 NI	2
27	FRANGE NUT	Ø3 NI	2
28	FIBER WASHER	Ø3 NI	2
29	INTERNAL TOOTH WASHER	Ø3 NI	2
30	HEATSINK	60X73X55 AL3F	2
31	HEATSINK	16X16 AL3F	1
32			
33			

DWG. NO. ASSY0290-01

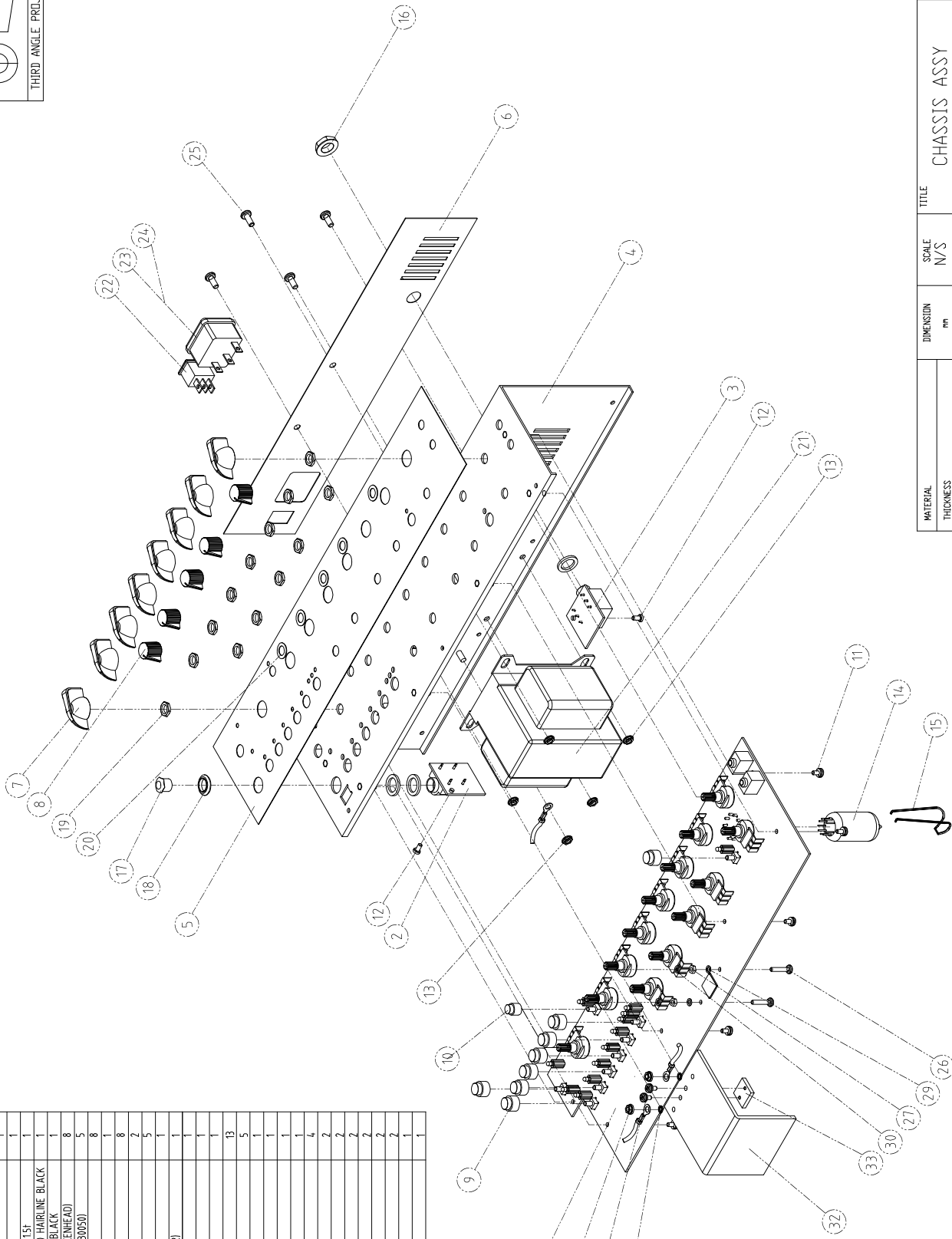

MATERIAL	DIMENSION	SCALE	TITLE	SHEET
THICKNESS	mm	N/S	CHASSIS ASSY	10F1
FINISH	MODEL	VT80+	DWG. NO.	VER.
TOLERANCE UNLESS NOTE	DRAWN	DATE	ASSY0291-01	A
DIMENSIONAL	S.Y. DH	2010.10.08		
HOLE CENTERS	CHECKED	DATE		
DIMETERS	APPROVED	DATE		
ANGULAR				

REV. NO.	REV. DATE	DESCRIPTIONS OF REVISION
C		
B		
A		



**KIMANSON**  
Kinson Instruments CO., Ltd.

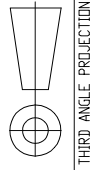

THIRD ANGLE PROJECTION

NO	DESCRIPTION	SPECIFICATION	Q'TY
1	CHASSIS ASSY	VT80+	1
2	SPEAKER	TSL3000989-1	1
3	CABINET ASSY	VT80+(450X260X411 PB 15H)	1
4	HANDLE BAR	PVC	1
5	HANDLE EDGE	ZN DIECASTING Cr	2
6	BRAND MARK	VOX (LARGE/SILVER)	1
7	VALVE IRONX	ABS BLACK + SILVER	1
8	VERT GRILL	ABS BLACK(LARGE)	3
9	RUBBER FOOT	SBR SMALL	4
10	SCREW	M3S 4X20 BK	10
11	SCREW	M3S 4X20 NI	4
12	SCREW	T1LSK 4X30 BK	8
13	SCREW	TWLS 3.5X15 BK	4
14	FRANGE NUT	M4 NI	4

DWG. NO. ASSY0294-02

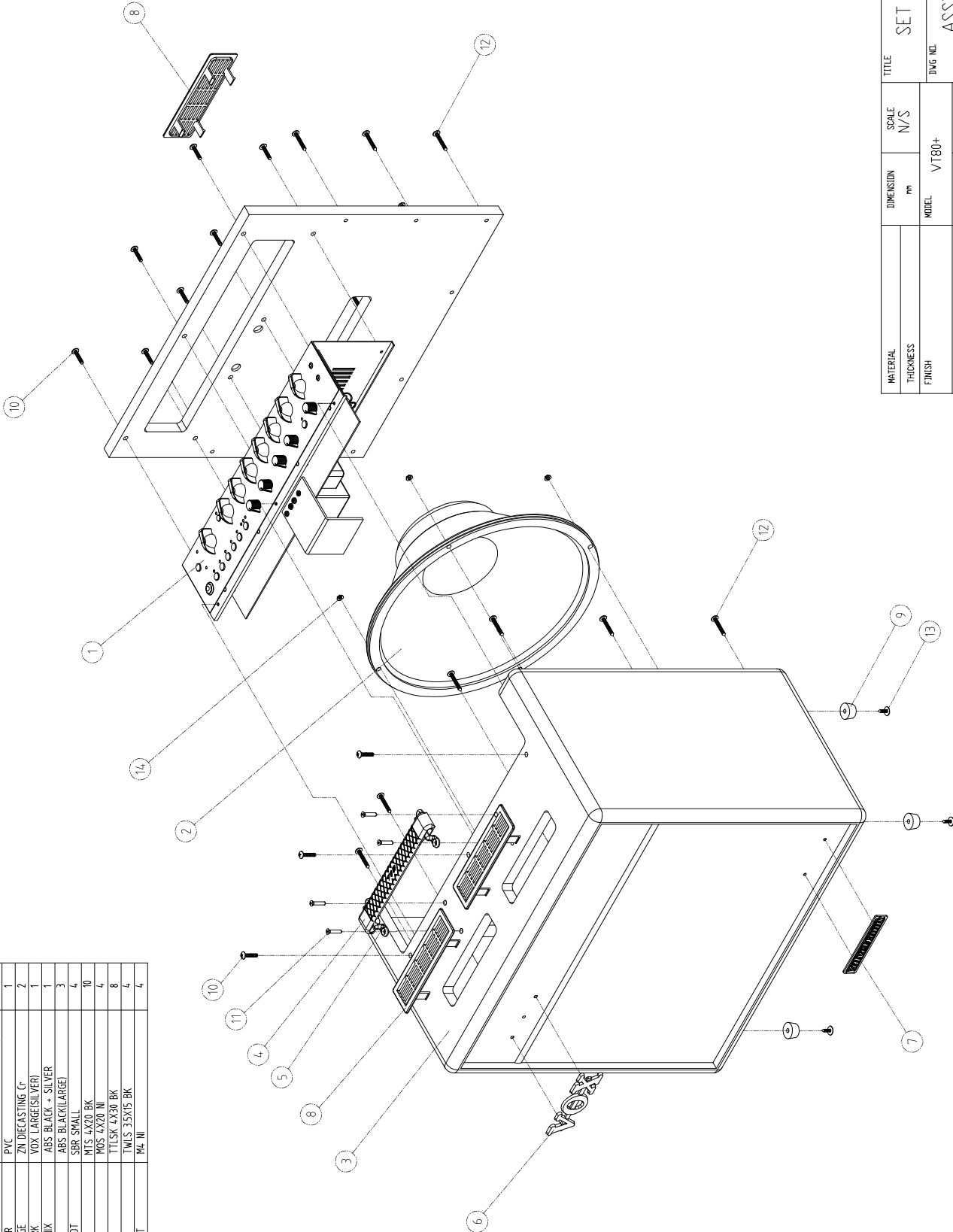

TITLE	SET ASSY	SHEET	10F1
DWG. NO.	ASSY0294-02	VER.	A
DIMENSION	mm	SCALE	N/S
MODEL	VT80+	DATE	2010.11.01
DRAWN	S.Y. DH	CHECKED	DATE
APPROVED	DATE		
TOLERANCE UNLESS NOTE			
DIMENSIONAL	±		
HOLE CENTERS	±		
DIMETERS	±		
ANGULAR	±		

REV. NO.	REV. DATE	DESCRIPTIONS OF REVISION
C		
B		
A		

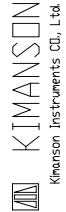

**KIMANSON**  
Kinson Instruments CO., Ltd.

# VOX VT20+/40+/80+/120+ testing instruction

Nov 15, 2010 fushimi@korg.co.jp

---

---

## Table of contents

---

2. Test mode	2
2.1.How to boot	2
2.2.Internal test	2
2.2.1.CPU-DSP I/F	2
2.3.Control surface test	3
2.3.1.Switch & LED	4
2.3.2.11-clicks VR	5
2.3.3.VR (non-click)	5
2.3.4.PHONES Jack, Audio Loop	6
2.3.5.Reload (DATA FLASH Initialization)	6
2.4.Audio test	7

## 2. Test mode

### 2.1. How to boot

Power on with switch indicated below being pushed to enter respective mode.

Release all switches after confirming the mode to be tested is correctly selected. Then enter the mode.

Modes	Switch to boot ( ● ) Initial status ( ● :lit, ■ :blink )
Internal test-> Control surface test.	
Audio test	

### 2.2. Internal test

In order to do switch test, connect VFS5 optional footswitch before boot the mode.

Item(s) below automatically will be inspected.

When NG occurred, LEDs lit/blink as below.

Test item	NG Indication ( ● :lit, ■ :blink )
CPU-DSP I/F	

Press PRESET SW and BANK SW together to check an NG item again after NG occurred.

Press PRESET SW and TUNER/BYPASS SW together to skip NG item and enter to next mode.

When internal test finished, mode shifts to control surface test mode automatically.

#### 2.2.1. CPU-DSP I/F



CPU reads DSP register data to check wiring between CPU and DSP.



### 2.3. Control surface test

Control surface and indicators are checked as below order.

Audio loop will be tested along with PHONES jack switch in test item 4.

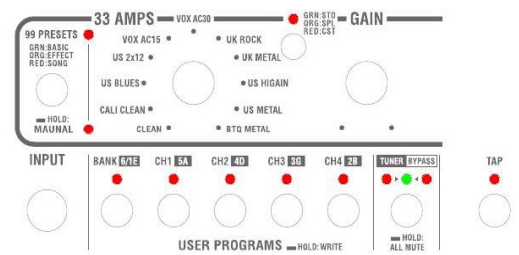
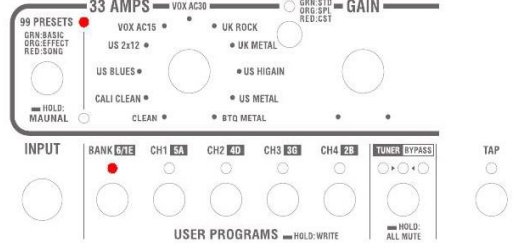
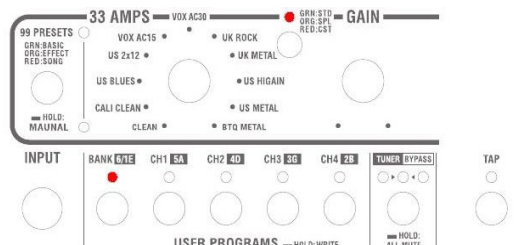
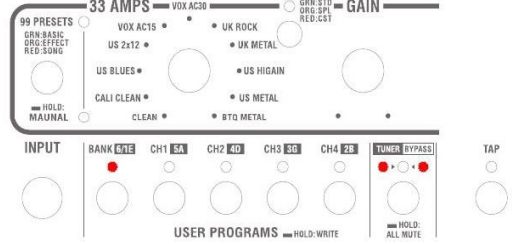
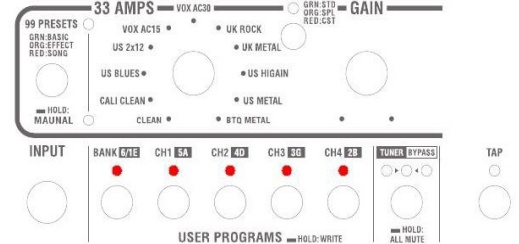
	Test item	Initial status (  :lit,  :blink)
1	Switch & LED	
2	11-clicks VR	
3	VR (non-click)	
4	PHONES Jack, Audio Loop	
5	Reload (DATA FLASH Initialization)	

---- Remarks ----

- In the initial status of switch & LED test, status of VFS5 is indicated on BANK, CH1~4 LED.
- Press BANK or TUNER SW when unit is initial status to choose each test mode.
- DSP will be muted except in test mode4.

### 2.3.1. Switch & LED

Check all LEDs are lighting (except green LEDs on PRESET, AMP, BANK)  
 Press TAP SW to check other switches and LEDs.

---- Remarks ----

- When BANK LED is blinking, BANK LED on VFS5 is green.  
 Then press BANK SW on VFS5 to make LED turn red.
- When either CH1,CH2,CH3,CH4 LEDs is blinking, CH SW on VFS5 is being pushed.  
 Release switches and make CH1~4 LEDs lit.

Check functions of all LEDs and switches in order.

1. Check LEDs in below chart lit correctly (others must not)
2. LED pattern change by pushing respective switch as below.

When all tests finished, enter to the next test automatically.

LED	Switch
PRESET (RED)	PRESET
PRESET (GREEN)	PRESET
MANUAL	PRESET
AMP (RED)	AMP
AMP (GREEN)	AMP
BANK (RED)	BANK
BANK (GREEN)	BANK
CH1	CH1
CH2	CH2
CH3	CH3
CH4	CH4
TUNER (LEFT)	TUNER/BYPASS
TUNER (GREEN)	TUNER/BYPASS
TUNER (RIGHT)	TUNER/BYPASS
TAP	TAP
BANK (RED), TAP	VFS5 BANK
BANK (GREEN), TAP	VFS5 BANK
CH1, TAP	VFS5 CH1
CH2, TAP	VFS5 CH2
CH3, TAP	VFS5 CH3
CH4, TAP	VFS5 CH4

---- Remarks ----

- All LED will blink when AMP TYPE knob turned during the test.  
 Press TAP switch to back to initial status of switch & LED test.

### 2.3.2. 11 - clicks VR

Check all click point on VR knob(w/click) as following order.

1. AMP TYPE (33 AMPS)
2. PEDAL TYPE
3. MOD/DELAY TYPE

Start test of knobs from their max position (rightmost).

If knob was set max initially, move the knob and set max again.

After checking min(leftmost) test on next knob starts automatically.

(Next test starts after MOD/DELAY test completed)

1. Stop knob at click point. (make sure knob is set on the point)
2. Go to next click after checking TUNER(GREEN) LED lit.

----- Remarks -----

- CH1 ~CH4 LED status changes according to A/D value of target knob(simple meter).
- If click point that was to be tested was skipped mistakenly before TUNER(GREEN) LED lit, TUNER(LEFT/RIGHT) LED will blink.  
Back to the click point to be tested then LED will go out and test can be re-started.
- If A/D value of other knob varied accidentally, error occurs and test stops with PRESET, BANK LED blink.  
Press TAP to cancel error status and re-start test.

### 2.3.3. VR (non - click)

Check A/D value of each VR (non-click)in the following order.

1. GAIN
2. VOLUME
3. TREBLE
4. MIDDLE
5. BASS
6. VALUE (PEDAL)
7. DEPTH (MOD/DELAY)
8. REVERB

Do test with each knob.

When all knob tests finished, next test starts automatically.

1. Turn knob to max (rightmost), (If knob was set max initially, move the knob and set max again).
2. Make sure TUNER(GREEN) LED lit.
3. Turn knob to MIN(leftmost), (when MIN is detected, TUNER(GREEN) LED turn off and goes to next step).

----- Remarks -----

- CH1 ~CH4 LED status changes according to A/D value of target knob(simple meter).
- If A/D value of other knob varied accidentally, error occurs and test stops with AMP, BANK LED blink.  
Press TAP to cancel error status and re-start test.

### 2.3.4. PHONES Jack, Audio Loop

CPU checks PHONES jack status. Signal level back to input by sending 1kHz sine wave from DSP will be checked.

1. Set "MASTER" max.
2. Connect PHONES jack and INPUT jack via mono cable.  
Check TAP LED lit when INPUT jack was connected to PHONES jack.
3. Press TAP switch (level check start).

When level check completed, next test will start automatically.

Output and input level (OK range) on each channel is a following.

(Each value corresponds to the one, when max signal input/output to/from DSP is set 1.0.

Test items	Output Ch (output level)	Input Ch (OK range)
DSP SI1R (Clean Ch)	DSP SO1L (0.015478)	DSP SI1R (0.35+-7dB)
DSP SI1L (Gain Ch)	DSP SO1L (0.001949)	DSP SI1L (0.35+-7dB)

---- Remarks ----

- When error occurs, PRESET, BANK, TUNER(LEFT/RIGHT) LED all blink and the test stops.  
PRESET LED color indicated which channel is causing error.  
(GREEN: Clean Ch, RED: Gain Ch).  
Press TAP switch to cancel error status and re-start test.

### 2.3.5. Reload (DATA FLASH Initialization)

Initialize all data such as USER PROGRAM and data on DATA FLASH.

Press TAP switch to start initialize. (BANK LED changes to green).

When initialize succeed, a unit will be goes to normal mode automatically.

---- Remarks ----

- When initialize failed, BANK, CH1-4 LED blink.  
Press tap switch to back to first step of "Reload".

## 2.4. Audio test

This is a bypass mode to through INPUT signal and output directly.

DSP input channel can be switched by pressing PRESET switch.

Power amp mute On/Off(AMP\_MUTE L/H) can be switched by pressing AMP switch.

Status of PHONES jack, VFS5 switch are shown on TAP LED, BANK,CH1-4 respectively.

Switch	Function	LED	Status
PRESET	DSP input L/R switch	PRESET=RED	L (Gain Ch)
		PRESET=GREEN	R (Clean Ch)
AMP	AMP_MUTE L/H switch	AMP=GREEN	High
		AMP=RED (Blink)	Low
PHONES Jack	PHONES jack status	TAP Off	Open (not connected)
		TAP On	Close (connected)
VFS5	VFS5 status	BANK=RED	BANK LED on VFS5 = RED
		BANK=GREEN	BANK LED on VFS5 = GREEN
		CH1 On	CH1 is pushed
		CH2 On	CH2 is pushed
		CH3 On	CH3 is pushed
		CH4 On	CH4 is pushed

# KORG VT80+ Parts List

⚠ = SAFETY CRITICAL COMPONENT.

EXP=EXPLODED VIEW Item No

Part Number	Category	Part Name	Location	EXP	Reference	QTY
530000001116	WAFER	WAFER LWL0640 3P	JACK		CN1	1
530000001945	PHONE JACK	BPJ-BNB-P, 8MM	JACK		J1	1
530000000797	PHONE JACK	PHONE JACK EPJ-BBB-P(8) STEREO	FOOT SW		J4	1
530000001094	OP-AMP	NJM072 (SMT)	MAIN		IC7	1
530000000194	OP-AMP	IC NJU7082	MAIN		IC5	1
530000002347	IC	POWER IC TAS5615	MAIN		IC8	1
500324018020	DAC	AK4384ET-E2	MAIN		IC4	1
500324018021	ADC	AK5358AET-E2	MAIN		IC11	1
530000000179	IC	IC 74LVU04DB	MAIN		IC2	1
530000001098	REGULATOR	UTC UR3325	MAIN		IC9	1
530000002307	REGULATOR	REGULATOR LM1117 5V	MAIN		IC6	1
530000002348	REGULATOR	REGULATOR KIA78L12F	MAIN		IC13	1
530000000279	TRANSISTOR	TR KTC4075	MAIN		Q2,Q3,Q4,Q18	4
530000002493	DIODE	ZENER DIODE 1N5256B (1/2W 30V)	MAIN		D22	1
530000002350	DIODE	ZENER DIODE 1N4739 (1W 9.1V)	MAIN		ZD2	1
530000002494	DIODE	ZENER DIODE 2EZ9.1D5(2W 9.1V)	MAIN		ZD3	1
530000001103	LED	3O4HD-7	MAIN		LED11	1
530000000208	LED	LED RED 3M/M DLL-B5131Q	MAIN		LED4,LED5,LED6,LED7,LED8, LED9,LED10,LED13	8
530000002196	LED	DLL-B2131Q(G124)	MAIN		LED14	1
530000001102	LED	3RG9HW-2-A	MAIN		LED1,LED2,LED3	3
530000000141	DIODE	BRIDGE DIODE KBU6K	MAIN		D7	1
530000002309	CRYSTAL	CRYSTAL 20MHZ	MAIN		X1	1
530000002495	RESISTOR	METAL OXIDE RESISTOR 2W 150	MAIN		R46	1
530000002496	RESISTOR	METAL OXIDE RESISTOR 3W 56	MAIN		R62	1
530000002358	RESISTOR	WIRE WOUND 5W 0.1 OHM	MAIN		R141	1
530000002497	RESISTOR	CEMENT RESISTOR 5W 56(SQP)	MAIN		R205	1
530000002318	VOLUME	SEMI VOLUME KV5F689AC103 (10K)	MAIN		VR14,VR15	2
530000000288	VOLUME	VR RV160-40-15S-B10K-C0	MAIN		VR1,VR4,VR5,VR6,VR7, VR9,VR11,VR12,VR13	9
530000002319	VOLUME	VOLUME VR RV160-40-15S-B1K-C0)	MAIN		VR2	1
530000000289	VOLUME	VR RV160-40-15S-B10K-C11 (11C)	MAIN		VR3,VR8,VR10	3
530000000265	SWITCH	TACK SW ATS-1230B (K=9.5MM)	MAIN		SW1,SW2,SW3,SW4,SW5, SW6,SW7,SW8,SW9	9
530000001101	TUBE SOCKET	GZC9-A	MAIN		Q11	1
530000002320	JACK	STEREO JACK CKX3.5-69	MAIN		J2,J3	2
530000002498	PCB ASS'Y	MAIN PCB ASS'Y(VT80+)	CHASSIS	1		1
530000002323	PCB ASS'Y	JACK PCB ASS'Y VT20+	CHASSIS	2		1
530000002324	PCB ASS'Y	FOOT S/W PCB ASS'Y VT20+	CHASSIS	3		1
530000002499	CHASSIS	MAIN CHASSIS(VT80+)	CHASSIS	4	CHA0339	1
530000002500	PANEL	FRONT PANEL(VT80+)	CHASSIS	5	FPN0220	1
530000002501	PANEL	REAR PANEL(VT80+ 100V)	CHASSIS	6	RPN0284	1
530000002502		REAR PANEL(VT80+ 120V)				
530000002503		REAR PANEL(VT80+ 230V)				
530000002504		REAR PANEL(VT80+ 240V)				
530000001126	KNOB	VOLUME KNOB CHIKEN HEAD CREAM	CHASSIS	7		8
530000001127	KNOB	ROUND KNOB	CHASSIS		KNOB0050	5
530000001124	KNOB	TACT KNOB "A" NBR 9PIE	CHASSIS	9	KNOB0047	8
530000001125	KNOB	TACT KNOB "B" NBR 7PIE	CHASSIS	10	KNOB0048	1
510465500501	TUBE	12AX7AC5HG	CHASSIS	14		1

530000001117	TUBE RETAINER	TUBE RETAINER	CHASSIS	15	SPR0012	1
530000002505	TRANS	TRANS 100V = 086-VT80+J	CHASSIS	21		1
530000002506		TRANS 120V = 086-VT80+U				
530000002507		TRANS 230V = 086-VT80+E				
530000002508		TRANS 240V = 086-VT80+EF				
530000000761	SWITCH	POWER SW RL3-421	CHASSIS	22		1
530000000199	Inlet	INLET/FUSE HOLDER SC-8F-21	CHASSIS	23		1
530000002509	FUSE	FUSE 100/120V = T4A L 250V	CHASSIS	24		1
530000000808		FUSE T2.0AL 250V				
530000002510	CHASSIS ASS'Y	CHASSIS ASS'Y(VT80+ 100V)	SET	1		1
530000002511		CHASSIS ASS'Y(VT80+ 120V)				
530000002512		CHASSIS ASS'Y(VT80+ 230V)				
530000002513		CHASSIS ASS'Y(VT80+ 240V)				
530000002514	SPEAKER	SPEAKER TSL300G0989-1(VT80+)	SET	2		1
530000002515		CABINET ASS'Y(VT80+)	SET	3	CAB0410	1
530000000313		HANDLE ASS'Y	SET	4,5		2
530000000283		VENT GRILL ABS	SET	8		3
530000000252		RUBBER FOOT SBR SMALL	SET	9		4
530000002516		BAFFLE ASSY(VT80+)	SET			1
530000000138		BRAND MARK VOX (LARGE) SILVER	SET	6		1
530000000854		BRAND MARK VALVETRONICS SILVER	SET	7		1
500600006508	AC CORD	LY100JPVCTFLY35LY37(JP)	PACKING			1
530000000123		AC CORD 120V = KKP30-16A				
530000000124		AC CORD 230V = KKP4819R-16A				
530000000125		AC CORD 230V = KKP650-16A				
530000000126		AC CORD 240V = KKP550-16A				