

Title: Ipomoea Steel String Guitar		
Drawn by: RMM	Date: 7/15/07	
Size: 36 x 48	Layers This Sheet:	
28.70	Blocks	Neck
	Border	Body
	Linings	Notes
	Trussrod	Logotype
	Dimensions	Strings
	Reference Lines	Titleblock
	Hardware	BackBraces
	Printgrid	TopBraces
	Patches&Grafts	
	Bridges	
Scale: 1:1	Sheet 1 of 1	
Copyright (c) 2007 by R.M. Mottola		
This plan is made available for non-commercial use only and may not be redistributed. If this plan is obtained from any source other than LuizaoMottola.com it has been copied in violation of copyright.		

NOTES:

1. Headstock, fingerboard, and tailpiece in top view drawing are shown as if rotated parallel to the drawing plane.
2. Trussrod is LMI TRSD, 15.5".
3. Brace profiles shown are rough, before carving.

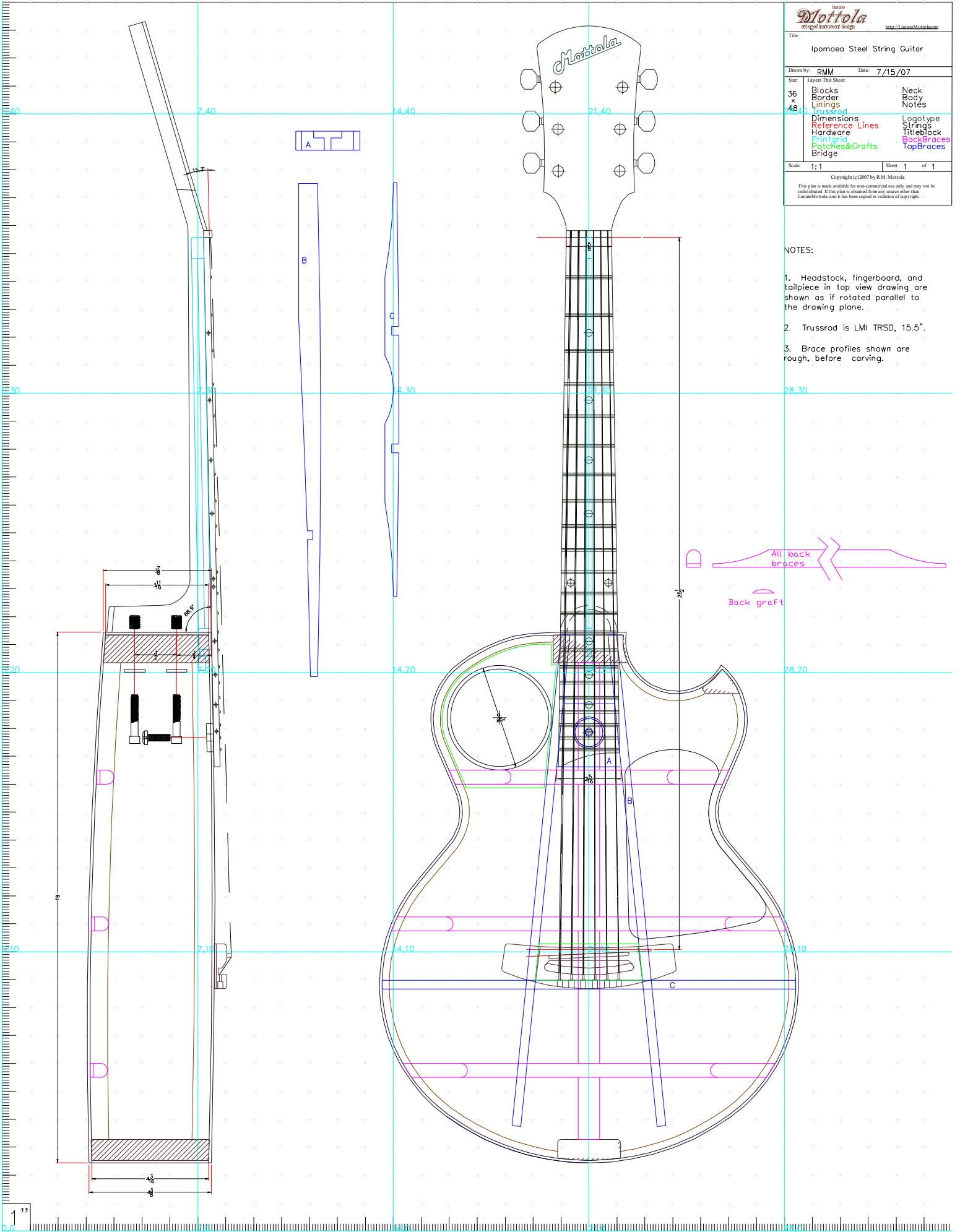

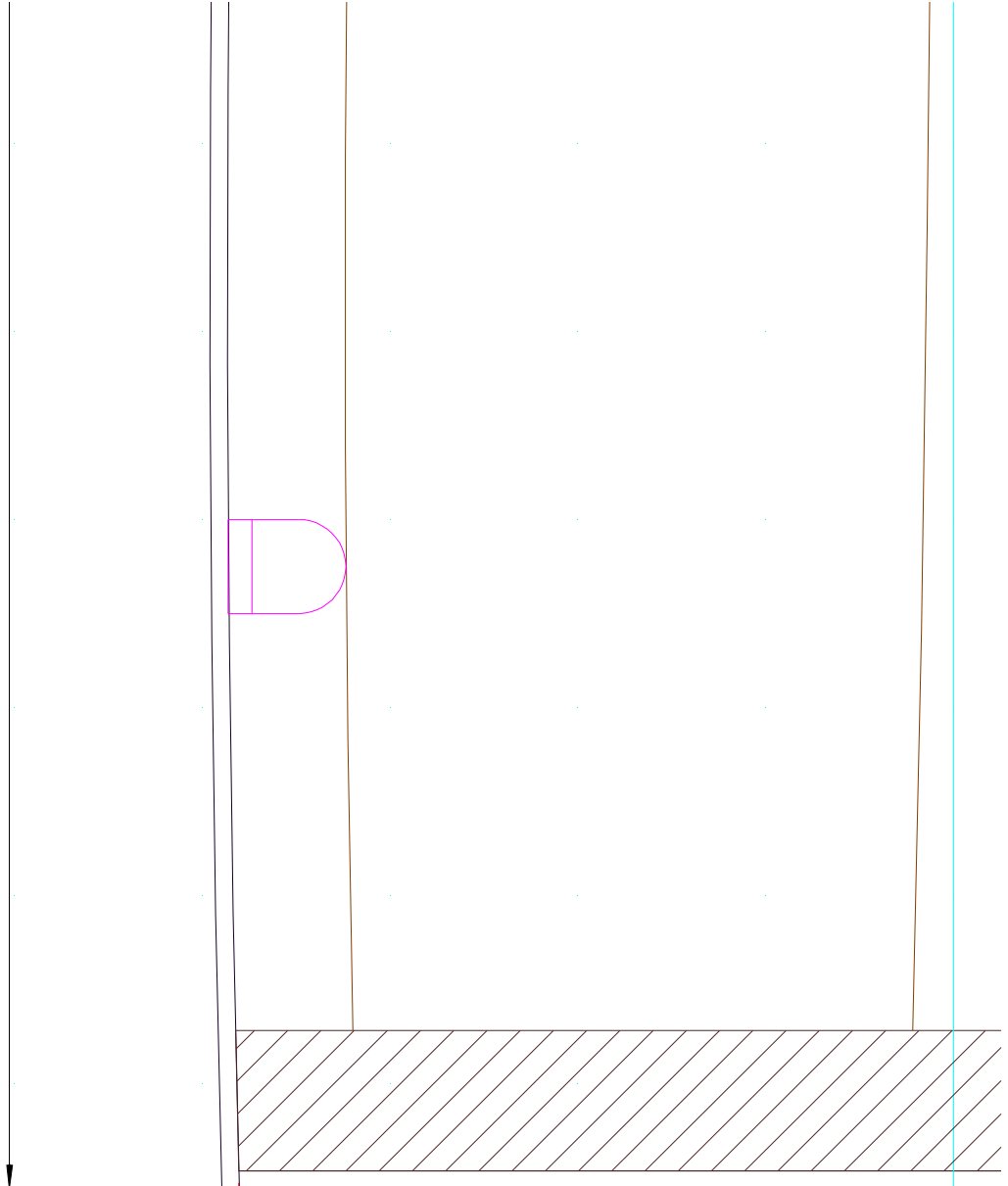

$4\frac{3}{16}$

$4\frac{3}{8}$

1 99
0,0

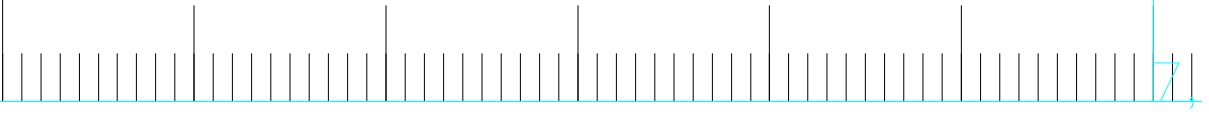

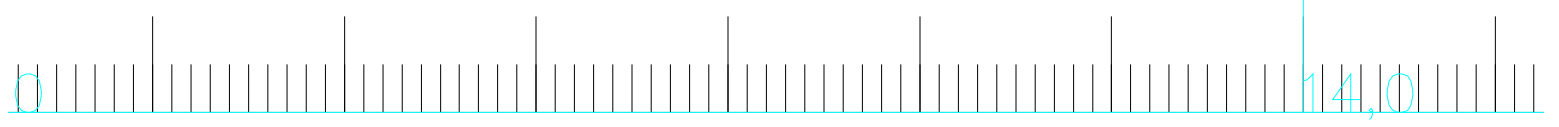
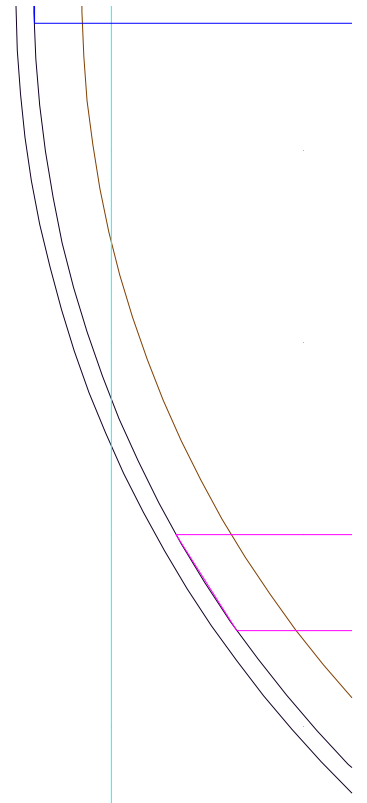
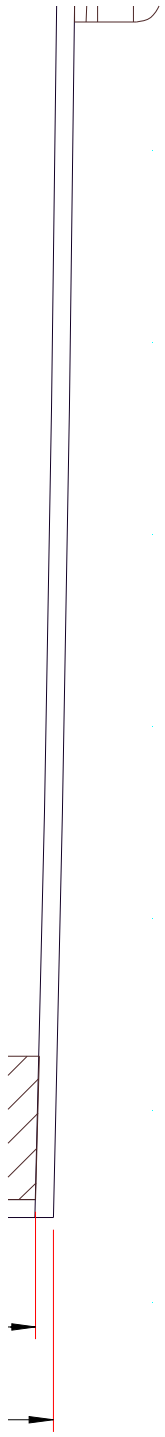

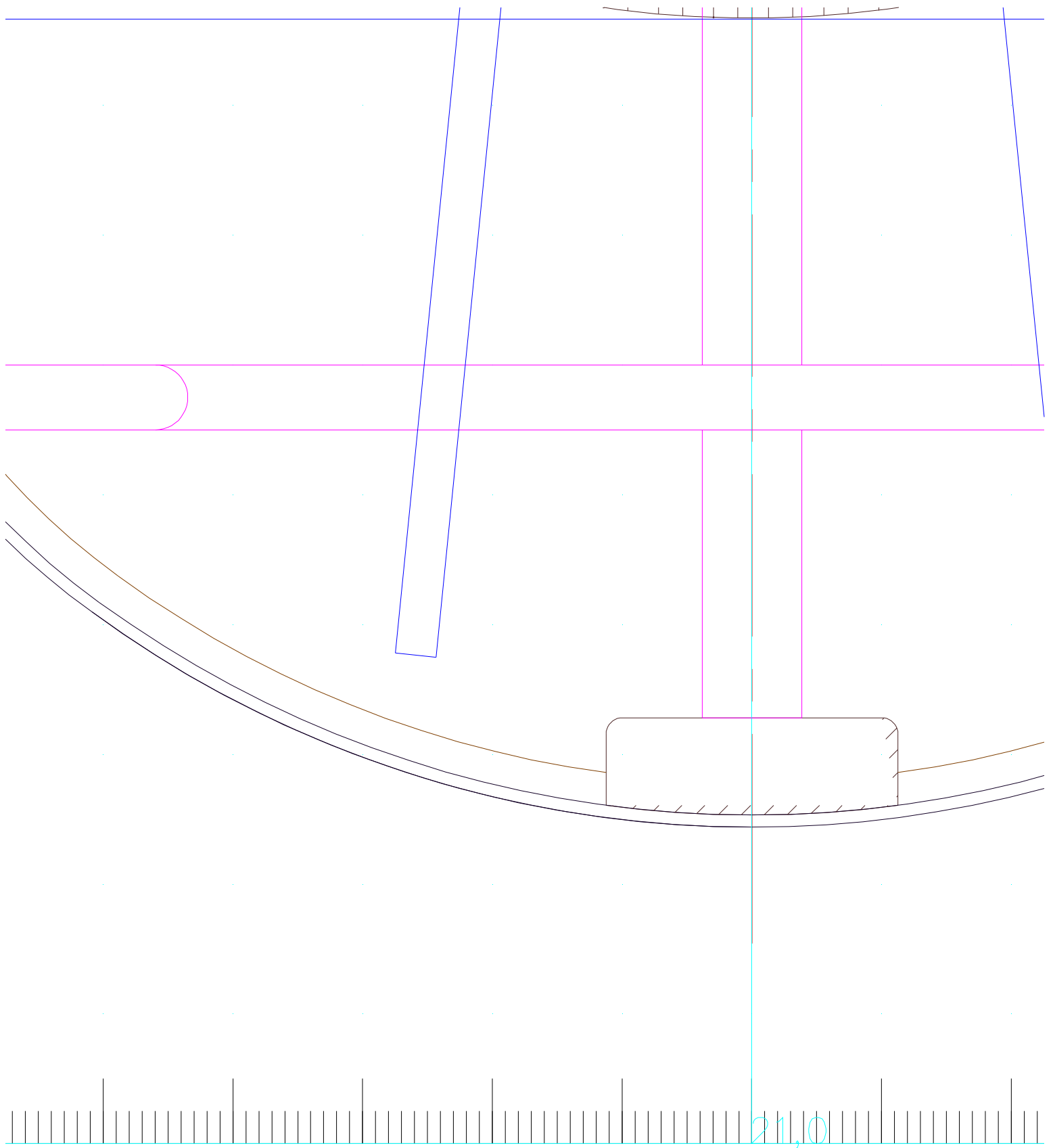

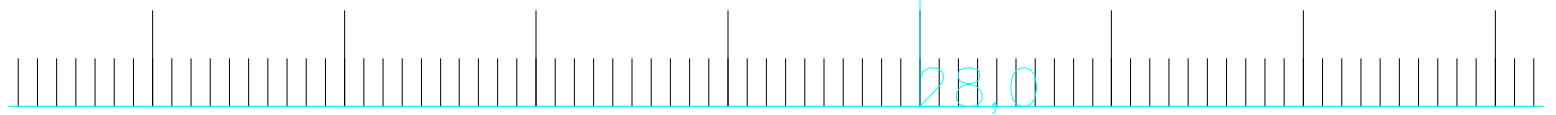
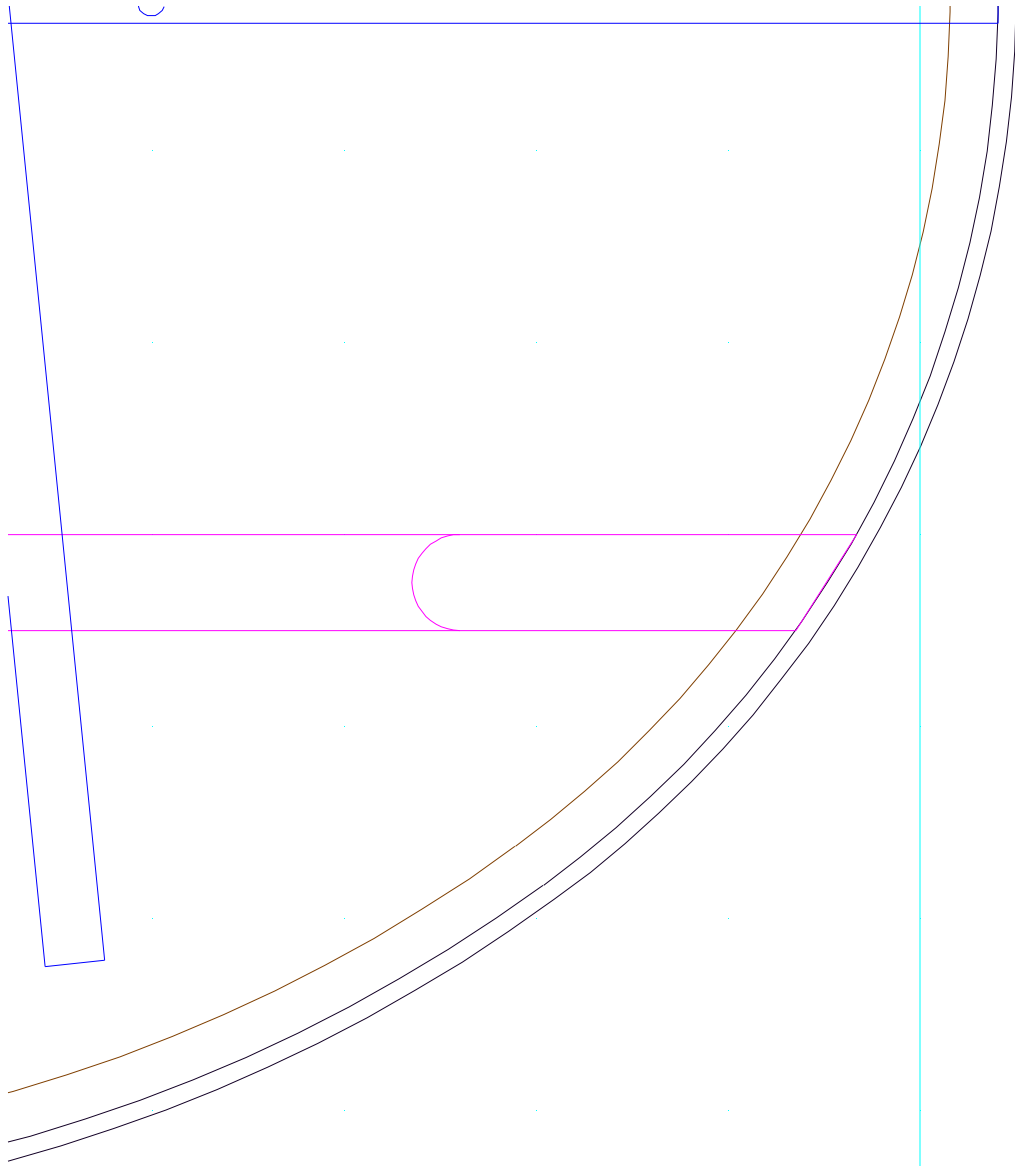





19

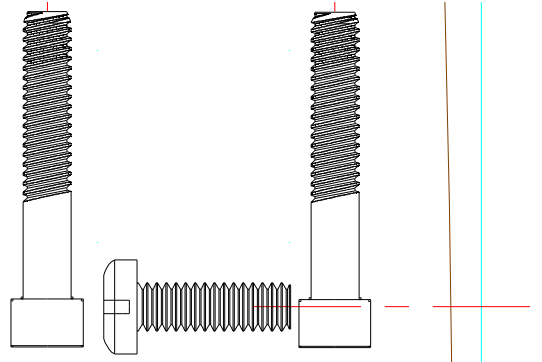
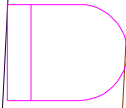
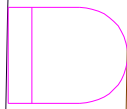

7

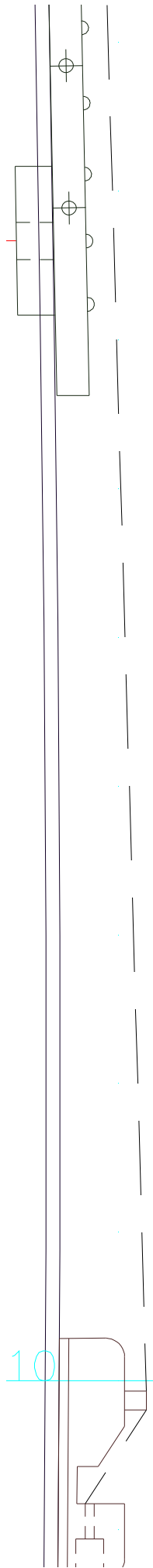

10

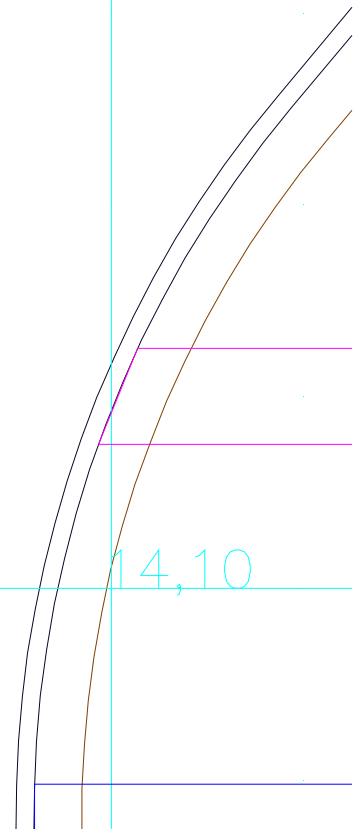

14,10

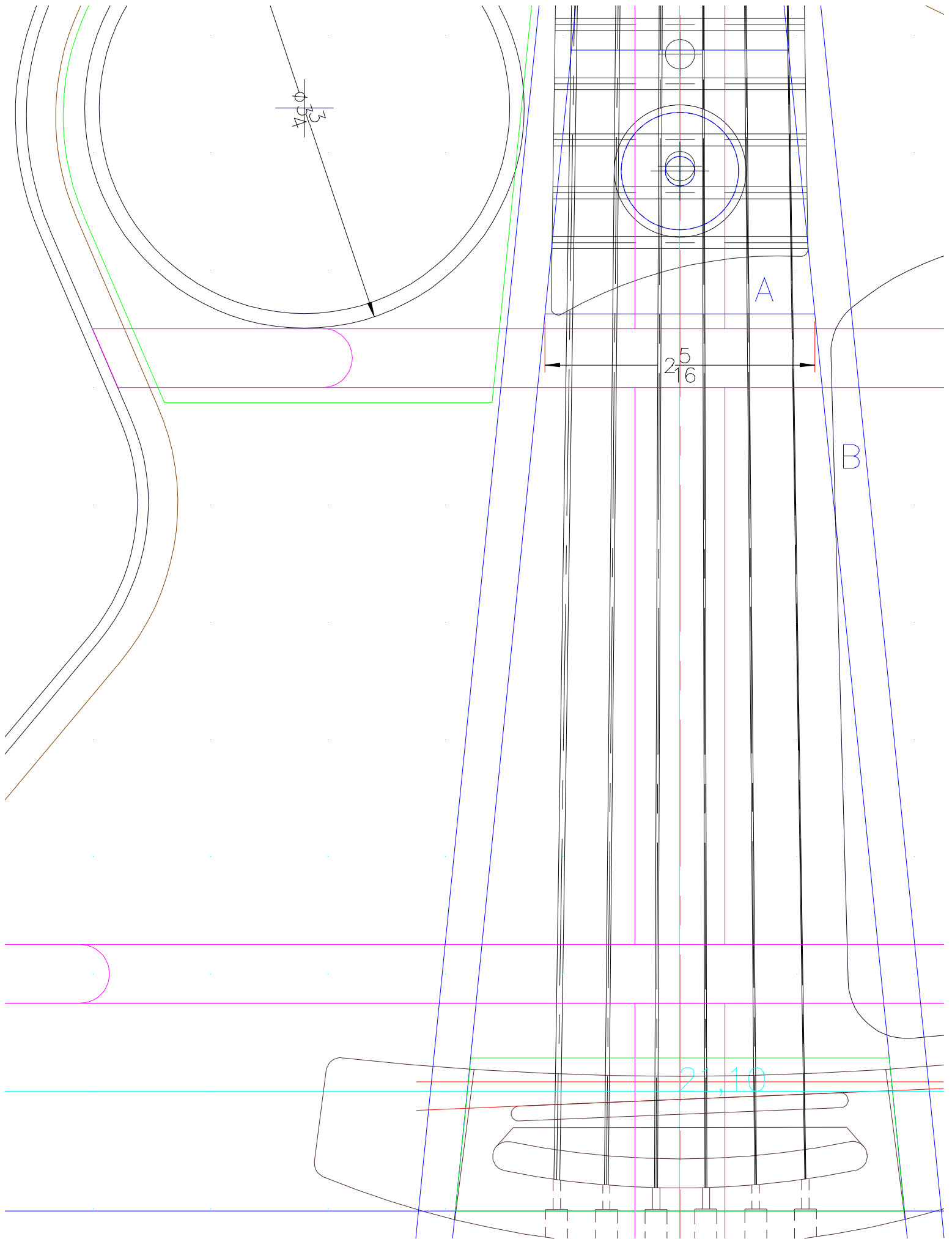

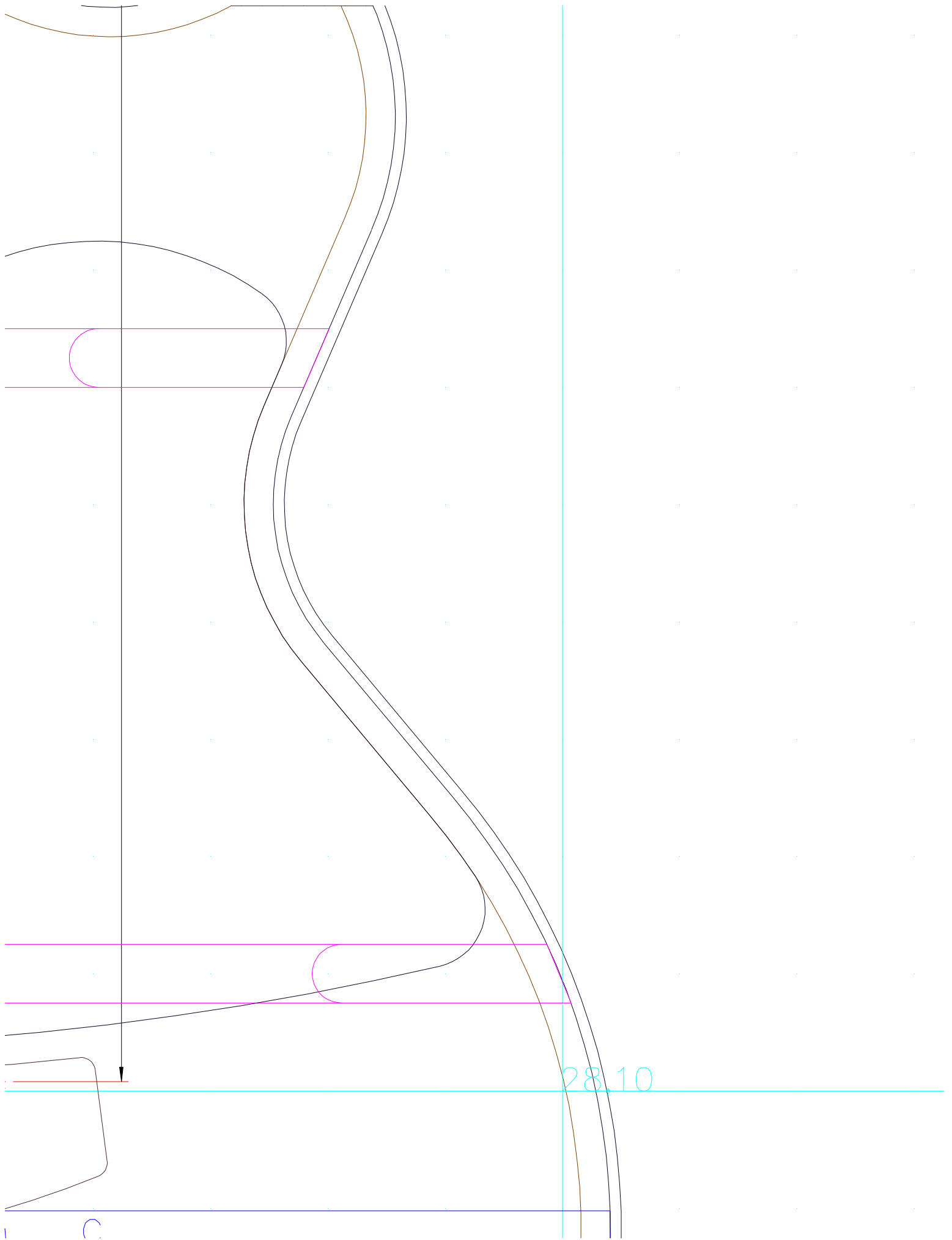

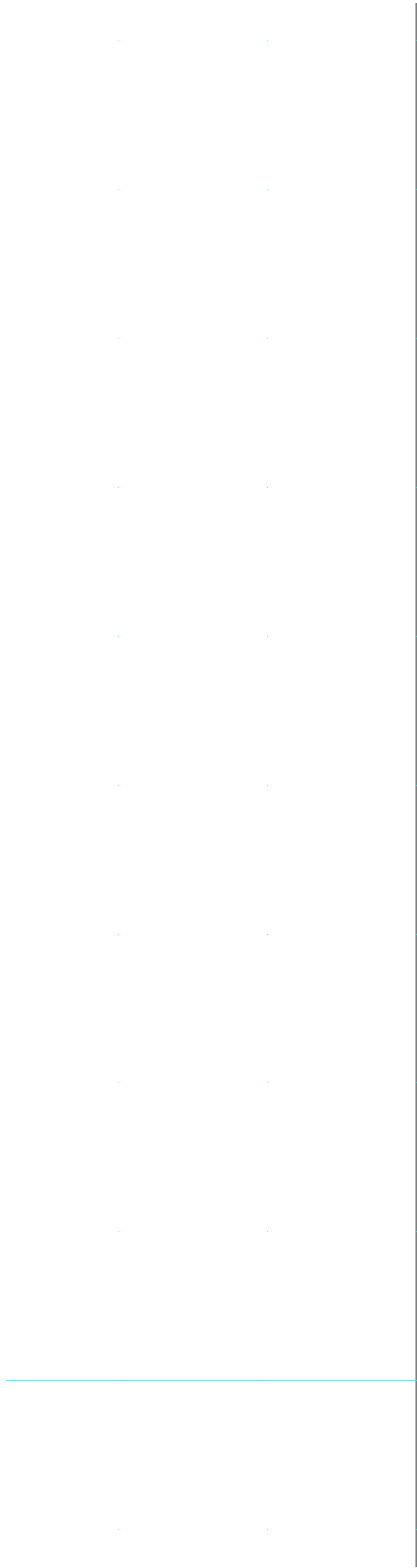



0,20

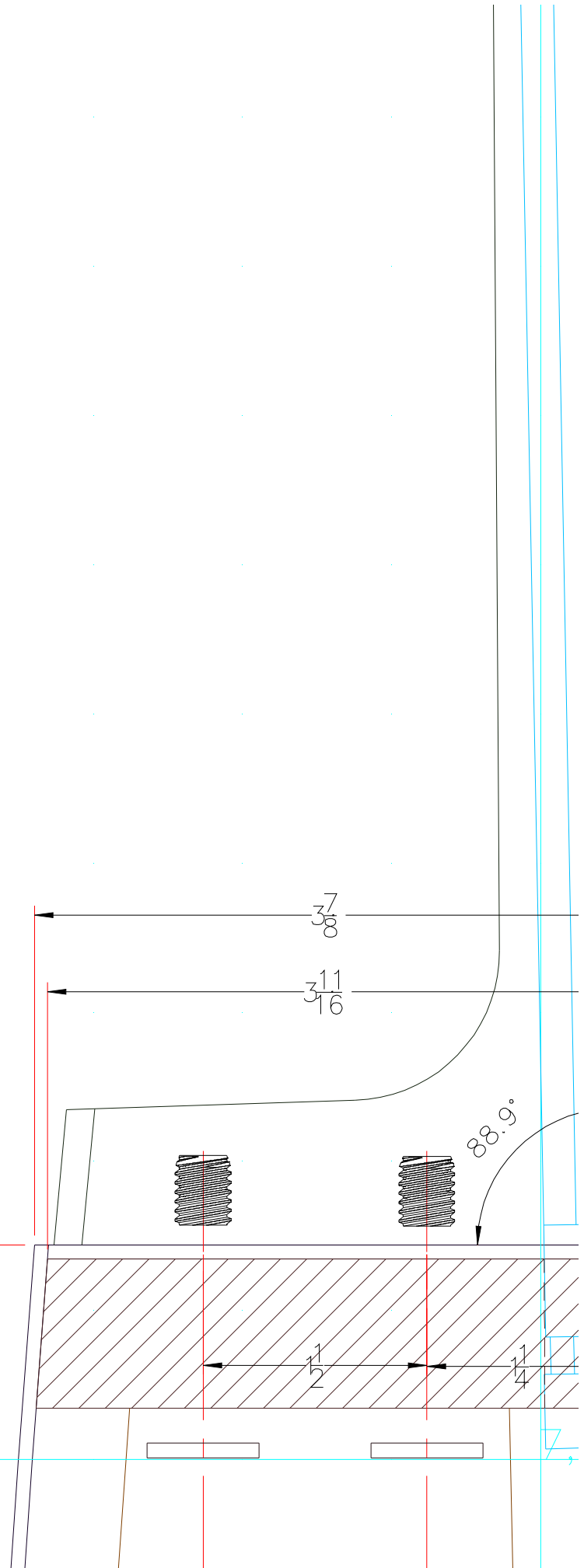

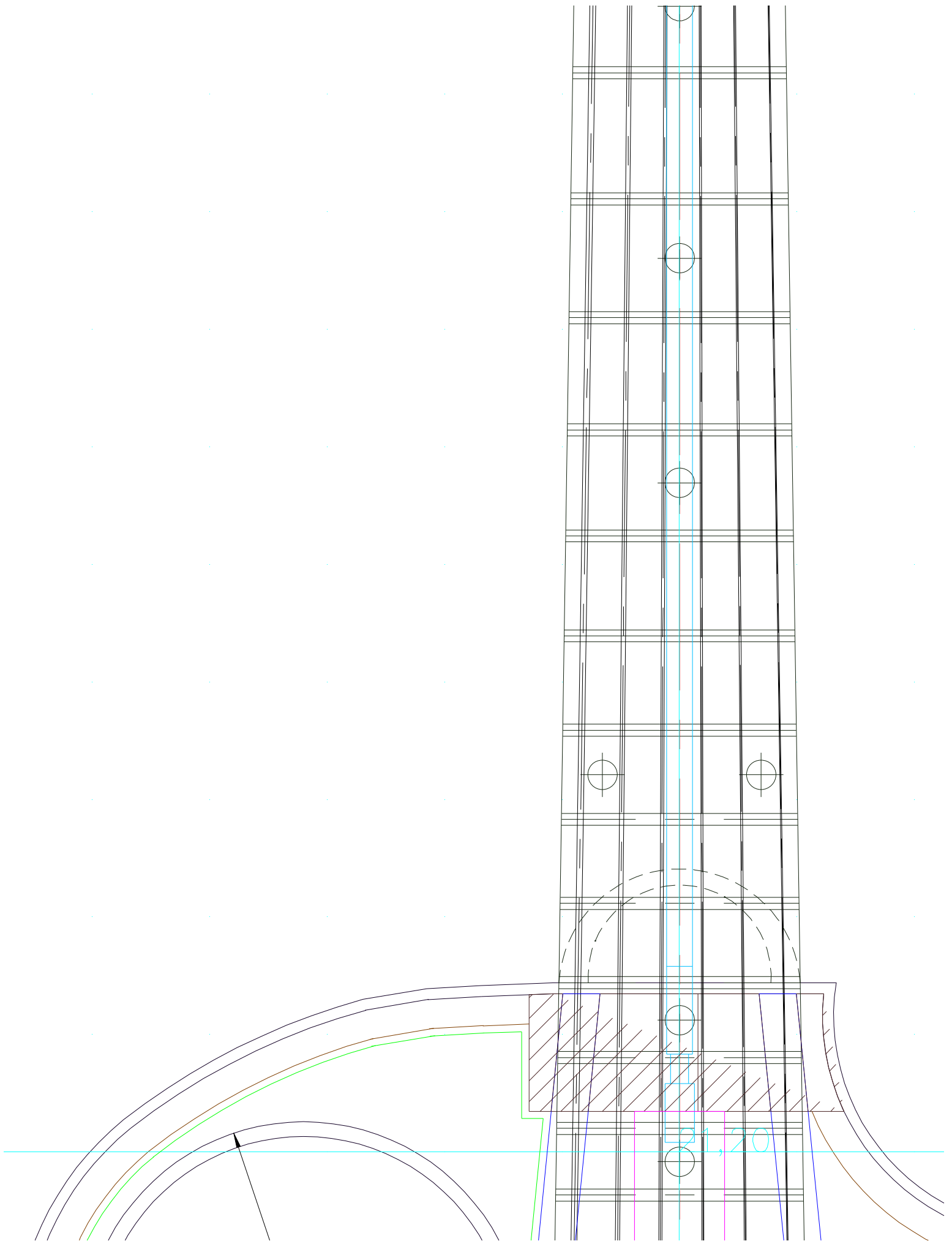

251
252

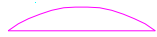
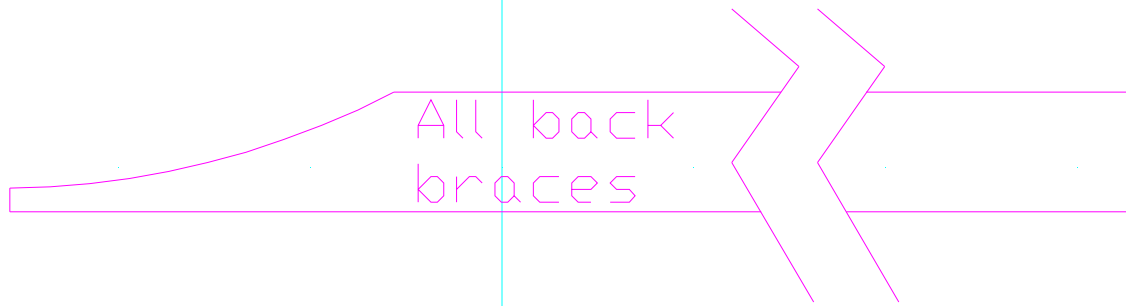
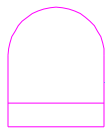

Back graft

28,20

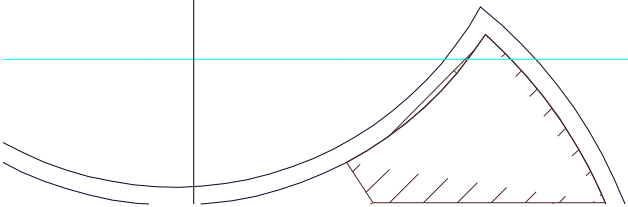

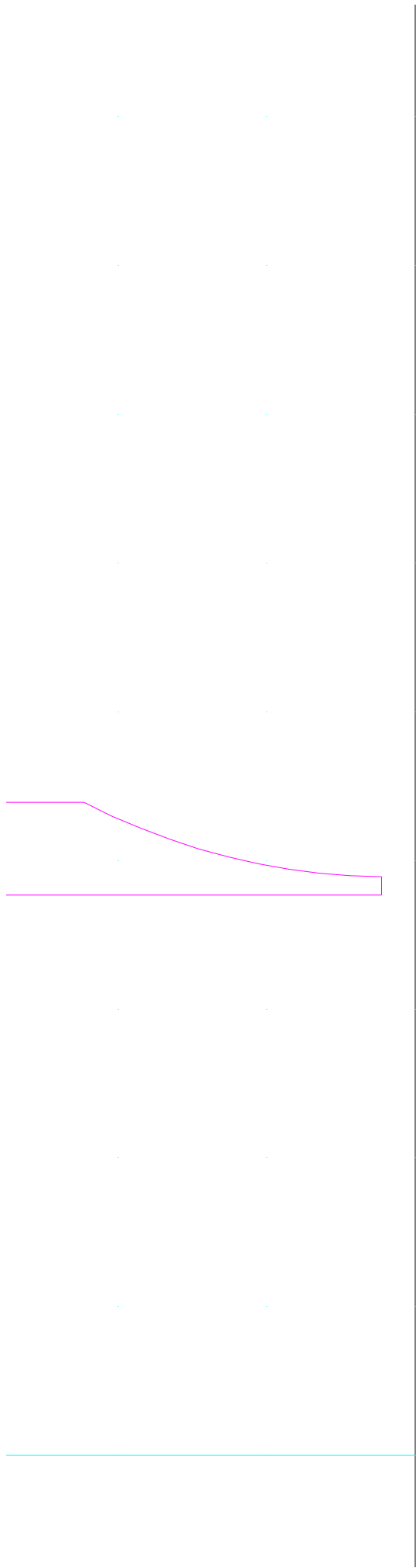

0,40



0,30

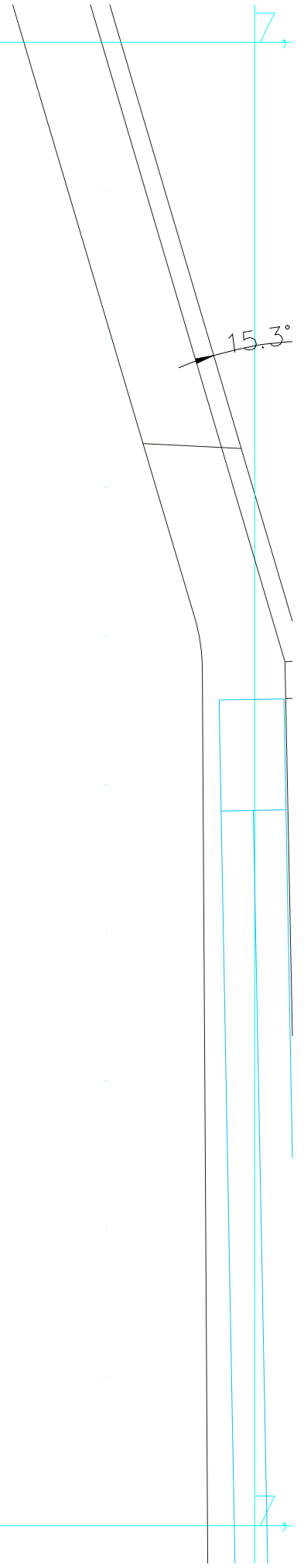

40

14,40

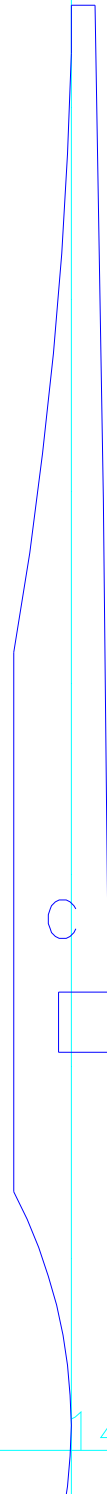
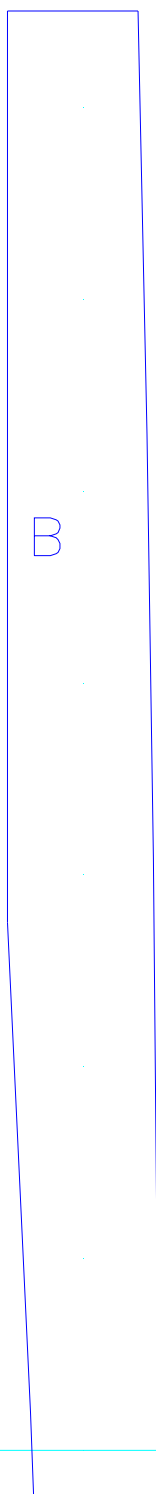
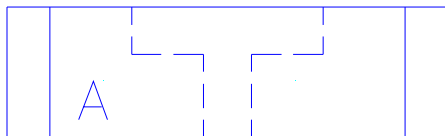

30

14,30

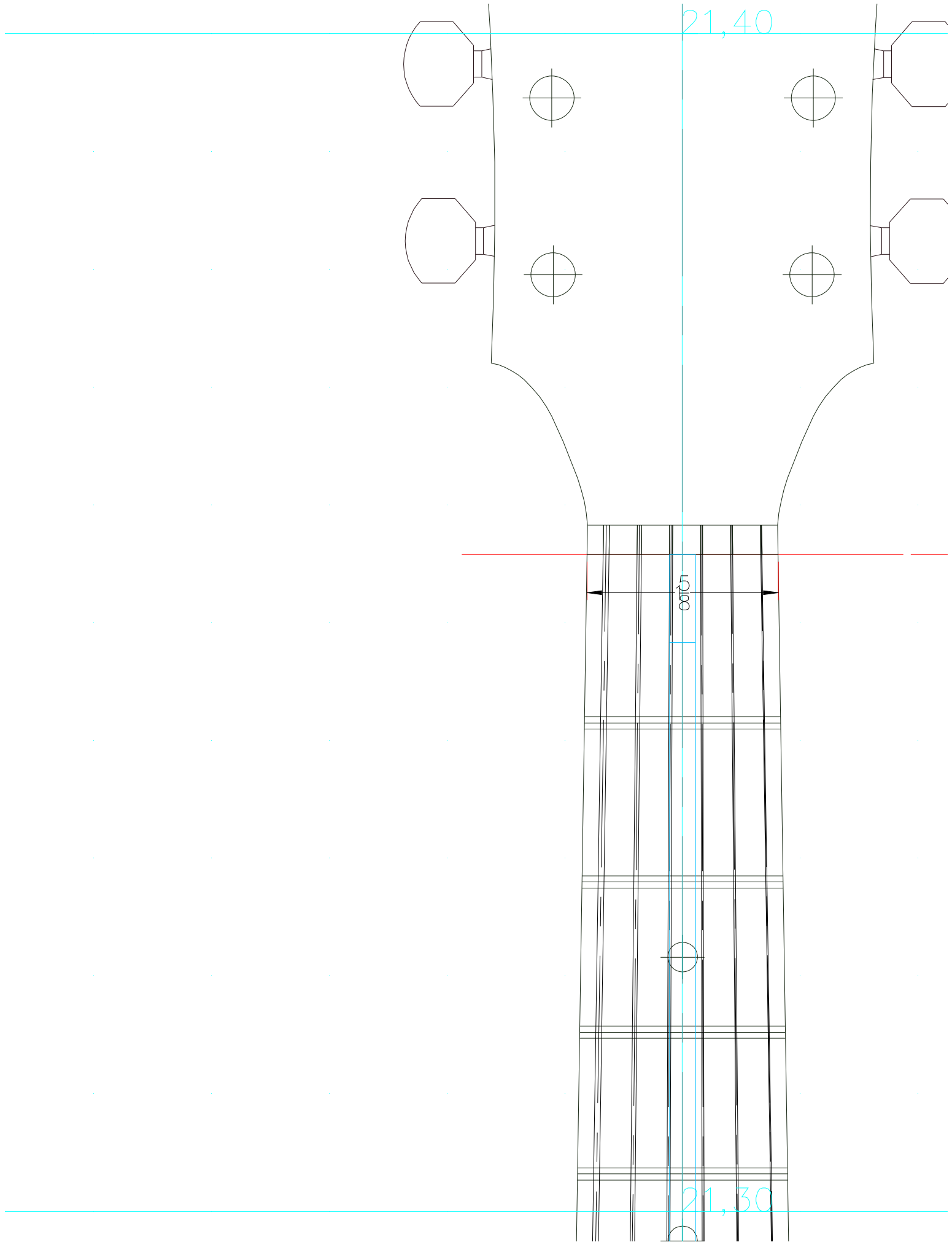

48
28,40 Trussrod

Dimensions
Reference Lines
Hardware
Printgrid
Patches&Grafts
Bridge

Scale: 1:1

Copyright (c) 2007 by

This plan is made available for non-commercial redistribution. If this plan is obtained from LiutaioMottola.com it has been copied in

NOTES:

1. Headstock, finger tailpiece in top view shown as if rotated the drawing plane.
2. Trussrod is LMI 1
3. Brace profiles shown rough, before carving

s

Logotype
Strings
Titleblock
BackBraces
TopBraces

s

Sheet 1 of 1

R.M. Mottola

Commercial use only and may not be
reproduced in any source other than
this drawing without a written
violation of copyright.

board, and
drawing are
parallel to

FRSD, 15.5”.

own are
g.

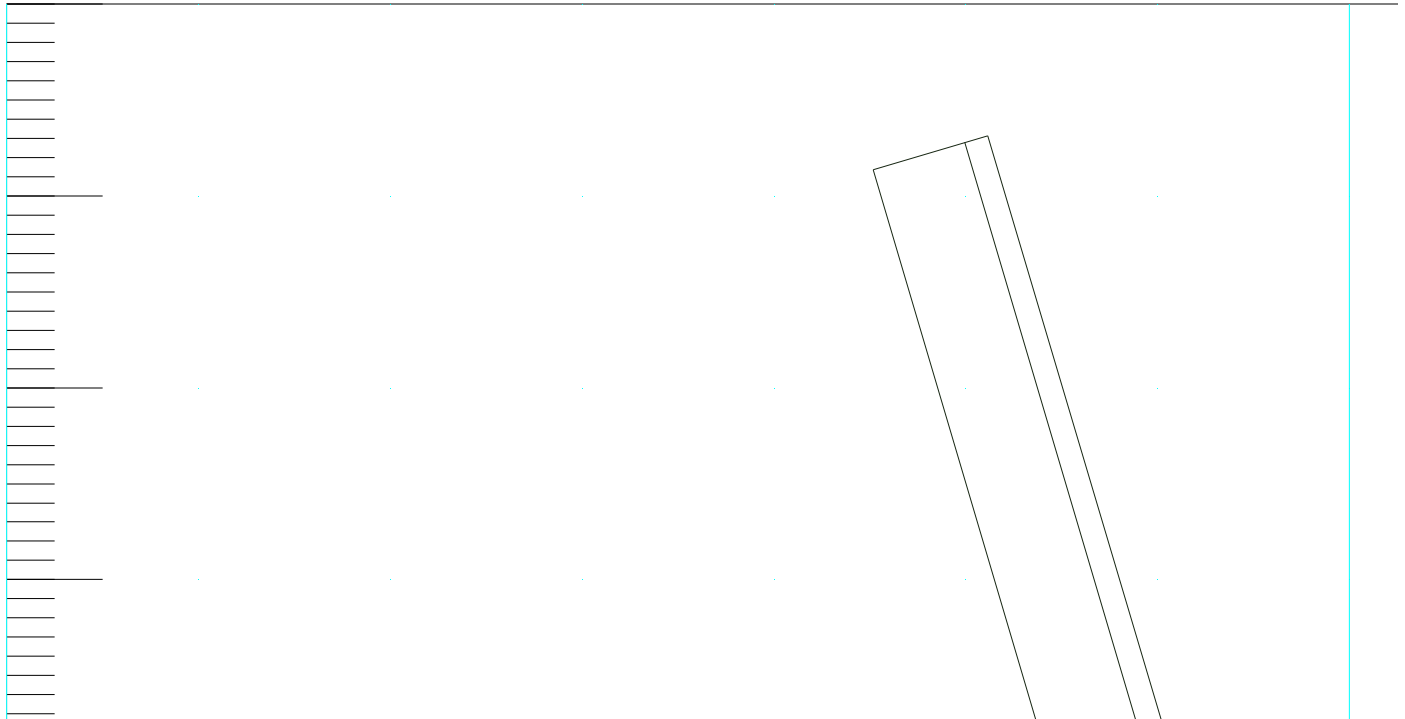

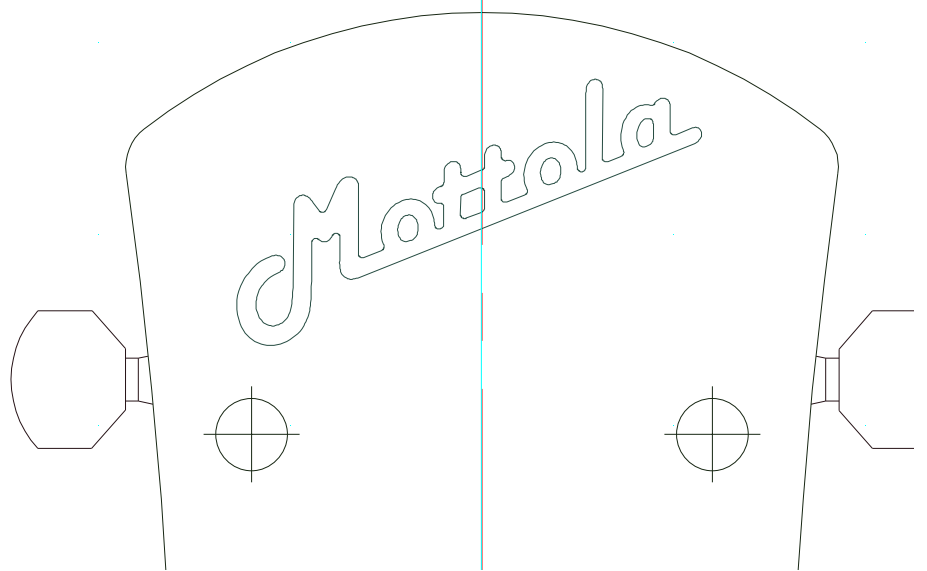

liutaio
Mottola
stringed instrument design

Title:

Ipomoea Steel S

Drawn by: RMM

Date:

Size:

Layers This Sheet:

36
x
40

Blocks
Border
Linings

<http://LiutaioMottola.com>

String Guitar

7/15/07

Neck
Body
Notes